

BASEMENT FLOOR CANADIANA

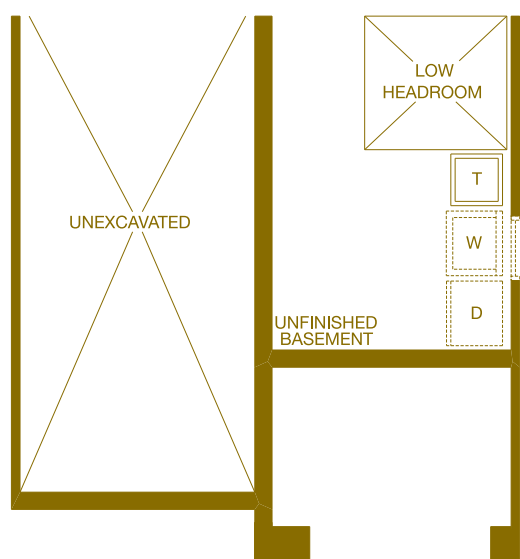

PARTIAL BASEMENT FLOOR ARTS & CRAFTS

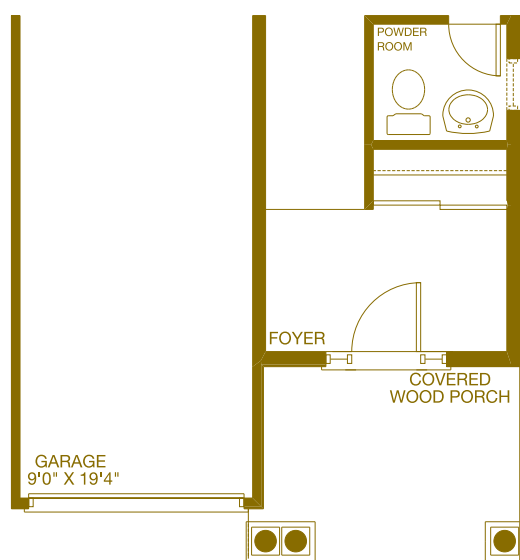

PARTIAL GROUND FLOOR ARTS & CRAFTS

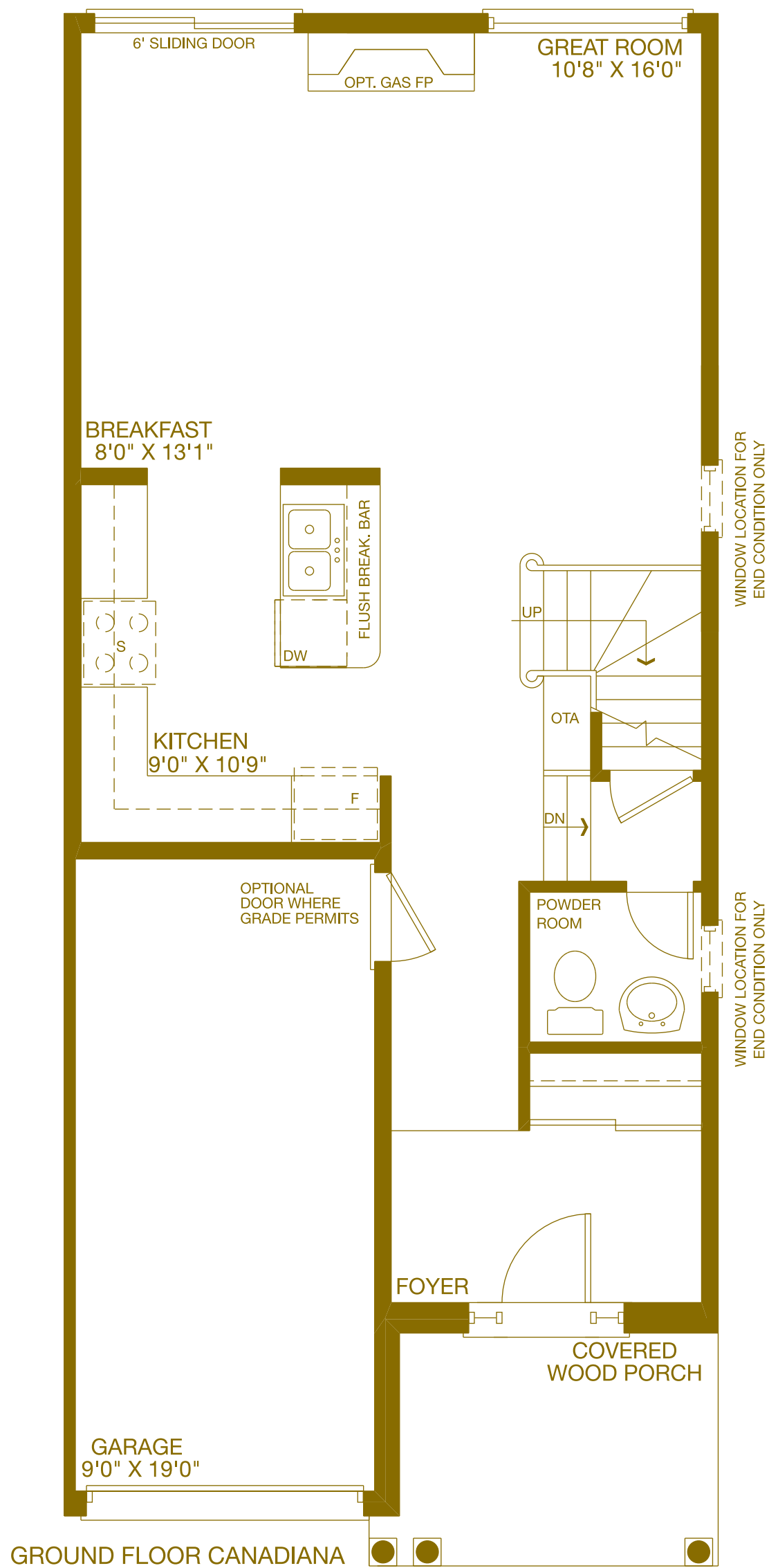

GROUND FLOOR CANADIANA

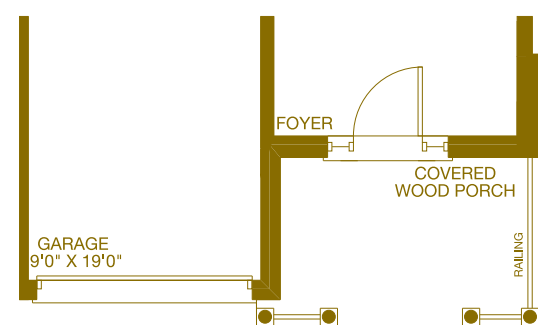

PARTIAL END PLAN GROUND FLOOR CANADIANA

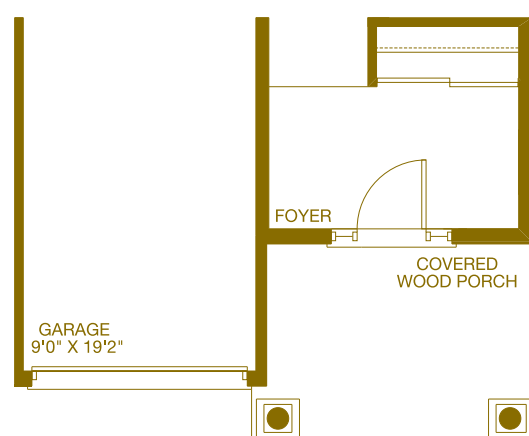

PARTIAL END PLAN GROUND FLOOR ARTS & CRAFTS

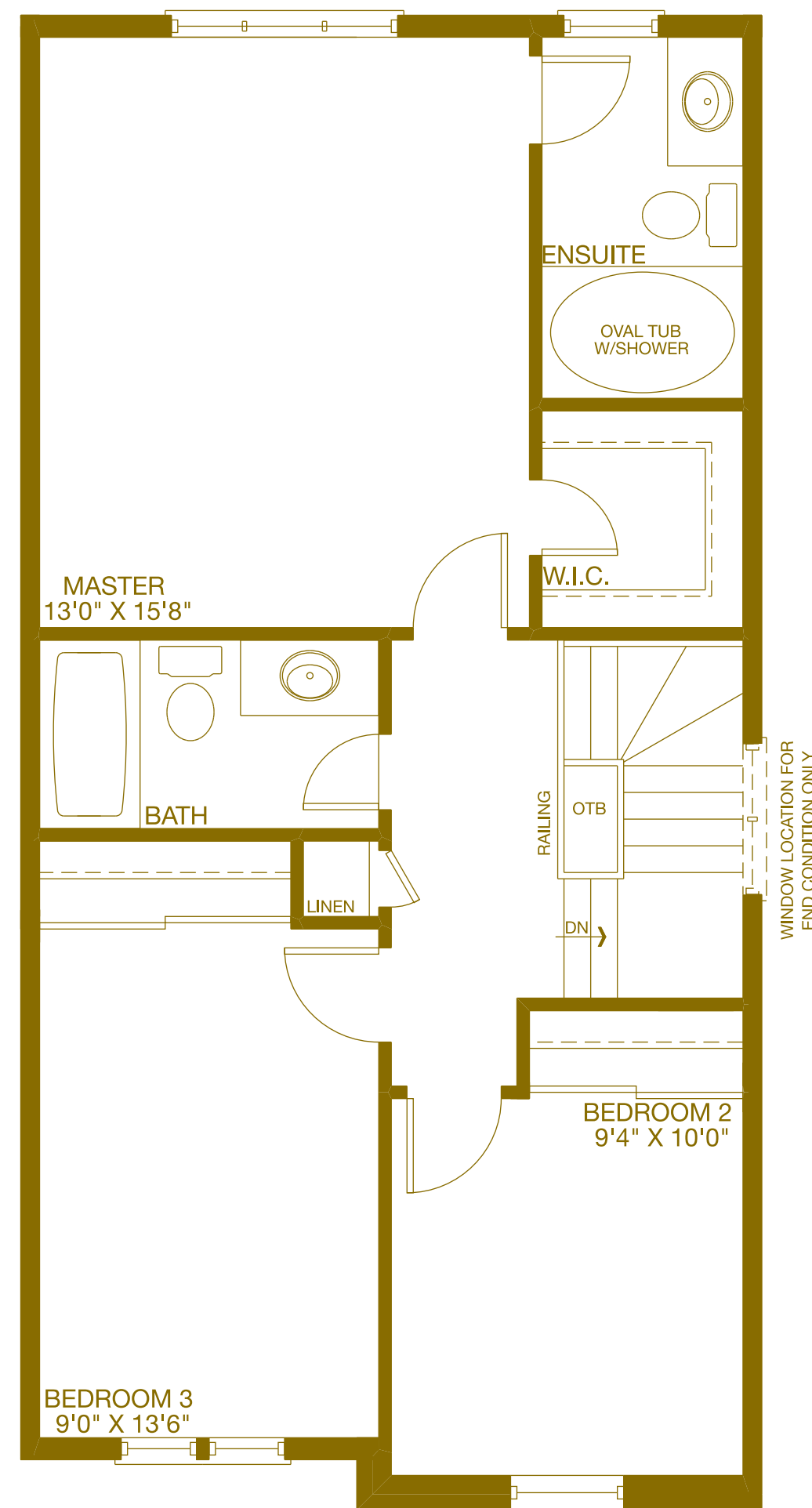

SECOND FLOOR CANADIANA

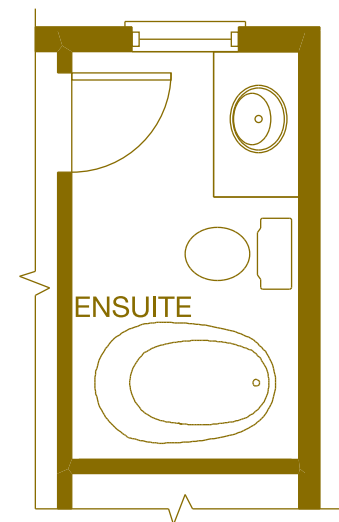

OPTIONAL ENSUITE LAYOUT

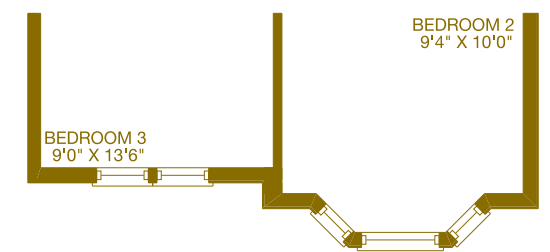

PARTIAL END PLAN SECOND FLOOR CANADIANA

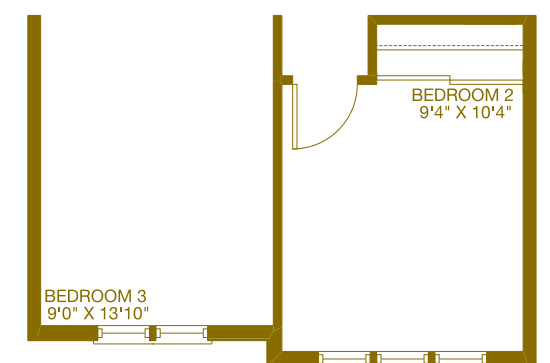

PARTIAL SECOND FLOOR ARTS & CRAFTS

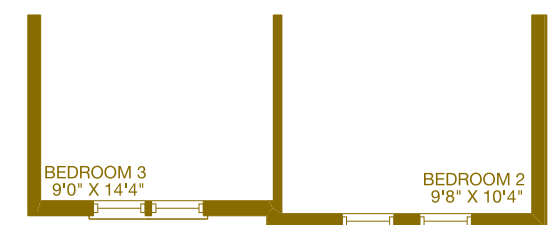

PARTIAL END PLAN SECOND FLOOR ARTS & CRAFTS

Peterson 1446 sq.ft.



Dimensions, specifications, layouts, window sizes, and materials are approximate only, may vary, and are subject to change as provided in the Agreement of Purchase & Sale. Square footage varies according to architectural style. Plans may be reversed. Illustrations are artist's concept. E.&O.E. TH-4.